

S-2500 / S-2501 ACOUSTIC SYSTEMS



KELONIK CINEMA SOUND

Screen Channel Cinema Sound System for medium theaters

K.C.S. S-2500 and S-2501 two-way speaker systems are high quality sets especially designed for the screen channel in medium sized cinema auditoria. These speaker systems include a direct radiation technology bass cabinet fitted with two 15" Ø woofers.

The high frequency section has a compression driver with 4" Ø titanium membrane, 2" Ø mouth and a constant directivity horn.



S-2500 system has a built-in passive crossover with 500 Hz cut frequency, while S-2501 is designed for biamplified applications and to operate with 500 Hz external electronic crossover.

S-2500 / S-2501 ACOUSTIC SYSTEMS

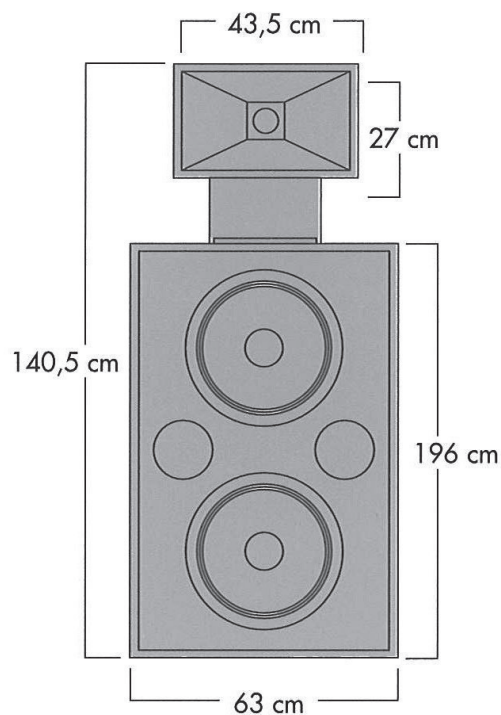

TECHNICAL DATA

	S-2500	S-2501
Frequency Range (-10 dB)	35 Hz – 20 kHz	
Nominal Impedance	4 Ω	LF 4 Ω HF 16 Ω
POWER CAPACITY		
Continuous Pink Noise ⁽¹⁾	700 W	LF 1400 W HF 80 W
Continuous Program	1400 W	LF 2800 W HF 160 W
Sensitivity 1W/1m	100 dB S.P.L.	LF 100 dB S.P.L. HF 110 dB S.P.L.
Crossover Frequency	500 Hz Passive included	500 Hz Active not included
Horizontal Beamwidth	90°	
Vertical Beamwidth	45°	
Dimensions (H x W x D)	140,5 x 63 x 47cm	
Net Weight	65 kg	61 kg

(1) Based on a 2 hour test using a continuous 6 dB crest factor pink noise signal band limited according to IEC 268-1 (1985).

COMPONENTS

	S-2500	S-2501
Cabinet	C-215-F	C-215
Low Frequency Driver	2 x S-1535	2 x S-1535
Passive Crossover	F-500/4C	-
High Frequency Driver	S-801	S-801
High Frequency Horn	S-201	S-201
Fixed Mount	SP-2F	SP-2F
Adjustable Mount	SP-2	SP-2